

Best printed on heavier print paper or cardstock

www.easypeasyandfun.com – For personal use and use in educational setting. Commercial use prohibited.

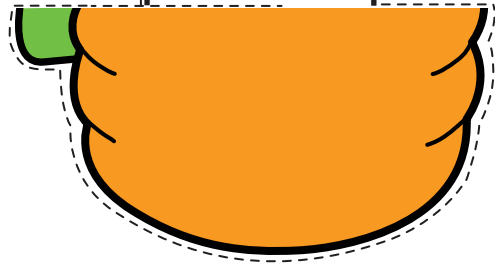
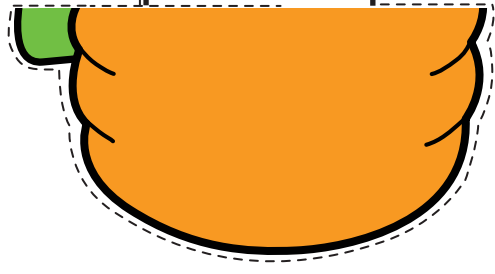
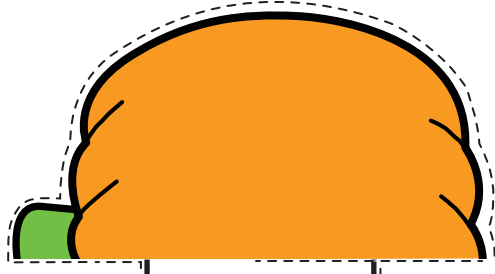
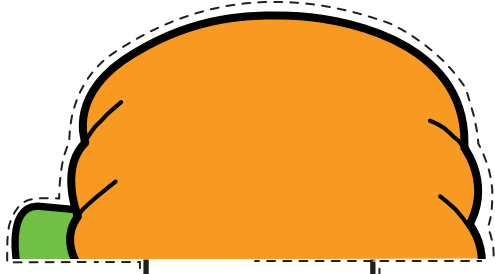

Best printed on heavier print paper or cardstock

www.easypeasyandfun.com - For personal use and use in educational setting. Commercial use prohibited.

1.

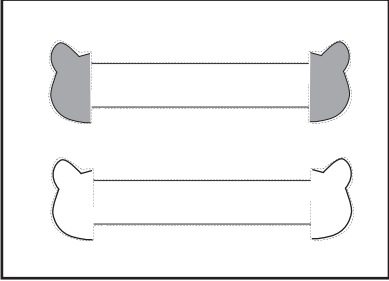

Print the bracelet

This panel shows two printed bracelet templates. The top one is grey and the bottom one is white. Both have a central rectangular section and decorative, rounded ends. A dashed line runs through the center of each template.

2.

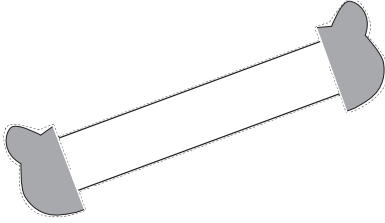

Cut along the dashed lines.

This panel shows the bracelet template from step 1 being cut along the dashed line. The cut pieces are shown at an angle to illustrate the process.

3.

Don't forget to cut along these dashed lines too!

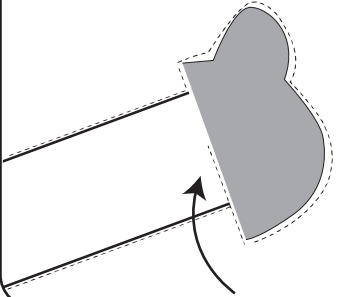

This panel shows the bracelet template from step 1 being cut along the dashed lines. The cut pieces are shown at an angle to illustrate the process. An arrow points to the dashed lines on the ends of the bracelet.

Bring the ends of the bracelet together (on your wrist) and push the slits one into the other.

4.

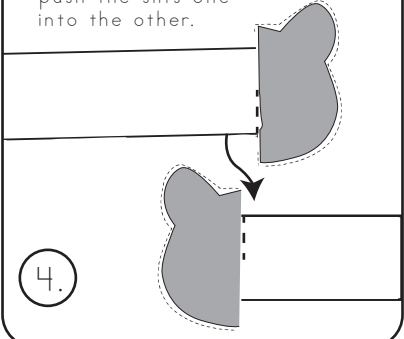

This panel shows the bracelet template from step 1 being assembled. The ends are brought together and the slits are pushed into each other. An arrow points to the slits.

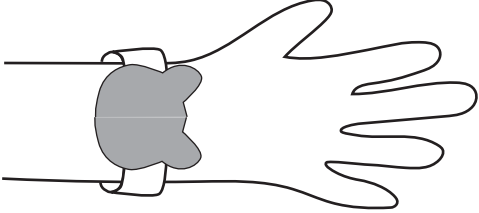

This panel shows a hand wearing the assembled bracelet. The bracelet is shown in grey and white, with the decorative ends visible.

1.

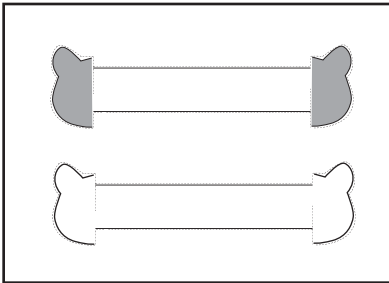

Print the bracelet

This panel shows two printed bracelet templates. The top one is grey and the bottom one is white. Both have a central rectangular section and decorative, rounded ends. A dashed line runs through the center of each template.

2.

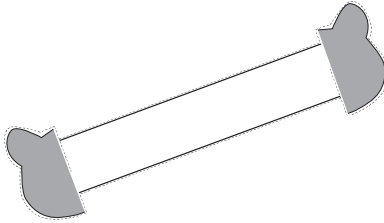

Cut along the dashed lines.

This panel shows the bracelet template from step 1 being cut along the dashed line. The cut pieces are shown at an angle to illustrate the process.

3.

Don't forget to cut along these dashed lines too!

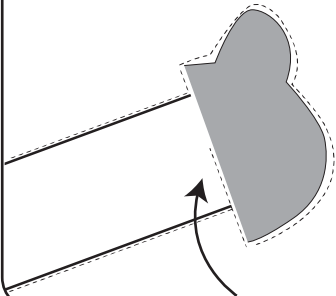

This panel shows the bracelet template from step 1 being cut along the dashed lines. The cut pieces are shown at an angle to illustrate the process. An arrow points to the dashed lines on the ends of the bracelet.

Bring the ends of the bracelet together (on your wrist) and push the slits one into the other.

4.

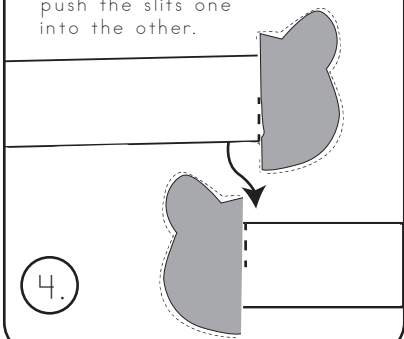

This panel shows the bracelet template from step 1 being assembled. The ends are brought together and the slits are pushed into each other. An arrow points to the slits.

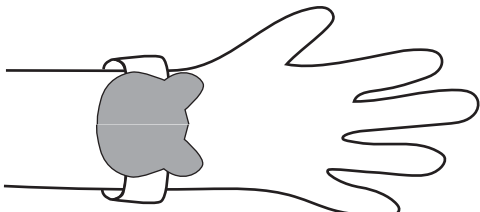

This panel shows a hand wearing the assembled bracelet. The bracelet is shown in grey and white, with the decorative ends visible.